

# Receptions

Gli elementi dedicati all'accoglienza. Tre differenti collezioni di mobili da reception per ufficio che si adattano perfettamente ad ogni esigenza: minimalismo, chiarezza costruttiva e linearità.

*The elements dedicated to welcoming areas. Three different collections for any need: minimalism, constructive clarity and clean design.*

**Led** P. 06



**Abako** P. 24



**Qubo** P. 40



# Led

DV702

L'espressione esatta di chiarezza costruttiva. Una linea dedicata all'arredo per reception, funzionale al dialogo e all'operatività. Funge da primo contatto, è l'elemento che relaziona l'utente con l'azienda attraverso una chiarezza lineare ben definita ed elegante.

*The precise expression of constructive clarity. A line dedicated to reception furniture, functional to dialogue and operation. It acts as a first contact, it is the element that relates the user to the company through a well-defined and elegant linear clarity.*











Ogni dettaglio della collezione è curato nei minimi particolari: delicate rotondità si contrappongono a linee decise.

*Every detail of collection is taken care of to the extreme: delicately rounded shapes contrast with clean lines.*





Con i suoi pannelli  
retroilluminati a led,  
i banchi reception  
trasformano l'ambiente  
circostante  
in pura magia.



*With its backlit panels  
it transforms the  
environment into pure  
magic.*





Moduli bancone e fianchi / Reception units and sides

Pannelli verticali sp. 1.8 cm in melaminico (\*) o laminato (\*\*)/  
Vertical panels 1.8 cm thick in melamine (\*) or laminate (\*\*)



Bianco lucido / Glossy white  
Noce "Maroncelli" / "Maroncelli" walnut  
Rovere chiaro / Light oak

Piani di lavoro sp. 1.8 cm, in melaminico /  
Worktops 1.8 cm thick, in melamine



Bianco / White  
Noce "Maroncelli" / "Maroncelli" walnut  
Rovere chiaro / Light oak

Zoccoli e profili in alluminio /  
Base metal frames and profiles in aluminium



Alluminio / Aluminium

Top sp. 1.5 cm, in vetro temprato retrolaccato /  
Top 1.5 cm thick, rear-lacquered tempered glass



Retrolaccato bianco / Rear lacquered white

Gambe terminali - intermedie in tubolare metallico /  
Tubular metal end - intermediate legs



Bianco / White  
Alluminio / Aluminium

Pannelli Led sp. 0.4 cm, in Metacrilato /  
Led panels 0.4 cm thick, in Methacrylate



Opalino bianco + telaio alluminio /  
Opal white + aluminium frame

Note

Su specifica richiesta è possibile ordinare abbinamenti tra pannelli e piani di lavoro diversi da quelli previsti a listino. Eventuali richieste di pannelli in metacrilato con illuminazione Led con colorazioni e finiture differenti, verranno valutate di volta in volta dall'ufficio commerciale. / On specific request, front panels, side panels, and worktops can be supplied in non-standard finishes. Requirements for special finishes for the methacrylate Led panels with lighting will be studied case by case by the commercial department.

Moduli bancone standard/Standard counter units

P 85,5 x H 112	L 85,5 P 85,5 x H 112	L 85,5 P 86,5 x H 112
702.MB.11.08_ L 80 702.MB.11.12_ L 120 702.MB.11.18_ L 180 Moduli dritti/Straight counter units	702.MB.13.08_ Raccordo 90° 2 vie /2 Way connection counter unit	702.MB.14.08_ Terminale 90° Dx - Sx /Terminal counter unit 90° R - L

Moduli bancone con Led/Counter units with Led

P 85,5 x H 112	L 85,5 P 85,5 x H 112	L 85,5 P 86,5 x H 112
702.MB.11.08_ + Led L 80 702.MB.11.12_ + Led L 120 702.MB.11.18_ + Led L 180 Moduli dritti/Straight counter units	702.MB.13.08_ + Led Raccordo 90° 2 Vie /2 Way connection counter unit	702.MB.14.08_ + Led Terminale 90° Dx - Sx /Terminal counter unit 90° R - L

Moduli bancone con piano conversazione/Counter units with conversation top

P 105 x H 74	L 82 P 8 x H 73	L 8 P 1 x H 34	L 8 P 1 x H 71,5
702.MB.12.12_ L 120 Modulo conversazione /Conversation counter unit	702.FC.13.08_ Dx - R/Sx - L Fianchi terminali conversazione /Terminal sides for conversation counter units	702.CT.A1.01 Copertura superiore conversazione /Upper cover element for conversation counter unit	702.CT.B1.01 Copertura terminale conversazione /Terminal cover element for conversation counter units

Componenti per bancone/Components for counter units

L 82 P 8 x H 108	L 8 P 1 x H 108
702.FC.11.08_ Fianchi terminali /Terminal sides Dx - R/Sx - L	702.CT.10.01 Copertura terminale /Terminal cover element

Gambe/Legs

702.GT.11.00 Gamba terminale /Terminal leg Dx - R/Sx - L	702.GM.11.00 Gamba intermedia /Middle leg	

Allunghi laterali/Lateral extensions

P 65 x H 74	P 80 x H 74	P 65 x H 1,8
801.TD.01.08_ L 80 801.TD.01.10_ L 100 801.TD.01.12_ L 120	801.TD.02.08_ L 80 801.TD.02.10_ L 100 801.TD.02.12_ L 120	801.AL.01.08_ L 80 801.AL.01.10_ L 100 801.AL.01.12_ L 120

Cassettiere portanti/Carrying pedestals

L 42 P 65 x H 72,2	L 42 P 65 x H 72,2	H 2,5
550.CS.30.04_	550.CS.40.04_	550.CG.11.04 Zoccolo (Optional) /Base frame (Optional)

Cassettiere/Pedestals

L 42 P 57 x H 55,5	L 32,2 P 54,2 x H 55,6	L 42,2 P 54,2 x H 55,6
550.CS.10.04_ Melaminico/Melamine	550.CS.1M.03_ Metalliche/Metallic	550.CS.2M.04_ Metalliche - Vaschetta porta cancelleria inclusa/Metallic - Stationery tray included

Note: Per portacancelleria cassette, vedi capitolo DV300-Accessori / For stationary tray, see chapter DV300-Accessories.

Canalizzazione - Elettificazione/Wire-Management - Electrification

P 10,2 x H 4,5	P 10,2 x H 4,5	L 80 P 10,2 x H 4,5
702.AP.01.08 L 80 702.AP.01.12 L 120 702.AP.01.18 L 180	702.AP.01.07	702.APT.1.08
		702.AP.09.00
		300.AP.V1.00

702.AP.03.01	300.AP.F1.00	702.DM.01.00	702.DM.02.00	702.AL.L6.00 30W/110 - 240V ± 12V	702.AL.L7.00 50W/110 - 240V ± 12V

300.AP.S1.02 L 20,5 300.AP.S1.03 L 30 300.AP.S1.04 L 42	300.AP.T4.01 300.AP.T5.01 - UK 300.AP.T6.01 - US	702.AC.01.00	300.AC.06.05	300.AP.T8.11 300.AP.T8.14 300.AP.T8.17 300.AP.T8.20	300.AP.T2.01 Ø 8

Bracci porta video/Arms for video support

300.AC.02.01 Braccio porta video mobile su piano /Dynamic arm for video support on deskbase

Note:

- Progettare la composizione del bancone ed aggiungere:  
n°1 gamba intermedia per ogni collegamento tra due moduli;  
n° 1 gamba terminale Dx o Sx, o fianco terminale Dx o Sx,  
o fianco terminale conversazione Dx o Sx per ogni lato finale del  
bancone; coperture terminali nella stessa quantità  
delle gambe terminali; copertura superiore per ogni collegamento  
tra modulo conversazione e modulo bancone;  
/ When designing the counter composition, add the following  
elements: n°1 middle leg for each connection between  
two counters; n°1 terminal leg (RH or LH) or terminal side (RH or LH),  
or terminal side for conversation counter unit (RH or LH) on each  
side of the counter unit; add the terminal covers elements according  
to the same quantity of terminal legs; upper cover element for  
the connection between the conversation counter unit and the  
standard counter unit;
  - Le dimensioni sono espresse in cm - consultare  
il listino prezzi per le caratteristiche tecniche, i codici  
degli articoli e delle finiture/Dimensions are stated in cm  
- for technical characteristics, article code numbers  
and finishing see price list;
  - Per la scelta dei contenitori e degli accessori vari,  
consultare il relativo listino o catalogo/To choose storage  
units and accessories, please check correspondent price  
list or catalogue;
- Articoli prodotti solo su richiesta/Items produced only on demand;
  - Fino ad esaurimento/Until exhaustion;
  - Con serratura/With lock;
  - Componenti non collegabili con modulo conversazione /Items that cannot be connected with the conversation counter units.
- Prodotti non in pronta consegna. Per la disponibilità contattare l'ufficio commerciale/Items not in prompt delivery. Please contact the commercial department to check availability;

# Abako

DV701

Arredo d'immagine e professionalità. Elementi lineari, linee arrotondate, dettagli ad alta valenza formale e inediti accostamenti di materiali; come un biglietto da visita dell'azienda, i banchi reception sono il primo luogo di contatto con il pubblico e l'esterno.

*Furnishing with image and professionalism. Linear elements, rounded lines, details of high formal valence and unusual combinations of materials; just as a business card, the reception is the first point of contact with the public and the outside world.*

















Moduli bancone in melaminico o laminato / Reception units melamine or laminate finishes

Pannelli verticali sp. 1.8 cm, in melaminico (\*) o laminato (\*\*)  
Vertical panels 1.8 cm thick, in melamine (\*) or laminate (\*\*)



Piani di lavoro sp. 2.5 cm, in melaminico /  
Worktops 2.5 cm thick, in melamine



Top sp. 1.2 cm, in vetro temperato /  
Top 1.2 cm thick, tempered glass



Gambe in metallo – Supporti top in zama Piedini in ABS /  
Metal legs – Die cast zama supports – ABS feet



Note

Per i colori e le finiture dei Frontal Panels, vedere il relativo capitolo in DV300 - Accessori. / For colours and finishes of Frontal Panels, see the chapter in DV300 - Accessories.  
■ Prodotti non in pronta consegna. Per la disponibilità contattare l'ufficio commerciale. / Items not in prompt delivery. Please contact the commercial department to check availability.

Moduli bancone dritti – Moduli bancone curvi 60° – Moduli bancone raccordo 90° / Straight counter units – 60° curved counter units – 90° counter corner units

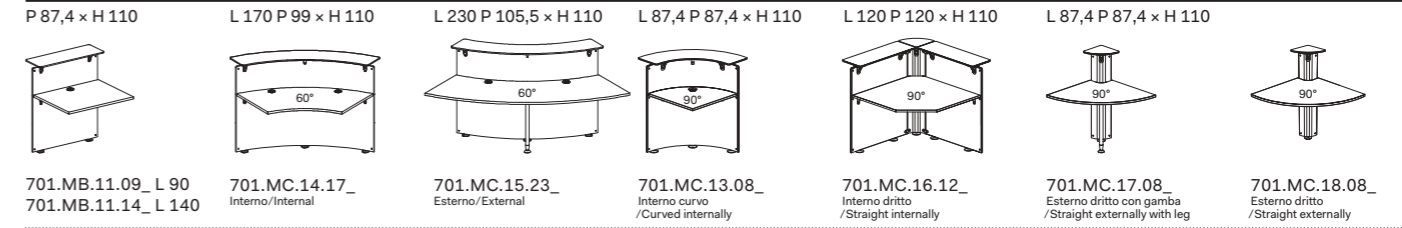

Note: Il top in vetro extrachiaro retrolaccato non è in pronta consegna. Per la disponibilità contattare l'ufficio commerciale / Extra-light rear-lacquered glass top is not in prompt delivery. Please contact the commercial department to check availability

Moduli bancone con piano conversazione – Gambe – Fianchi / Counter units with conversation top – Legs – Sides

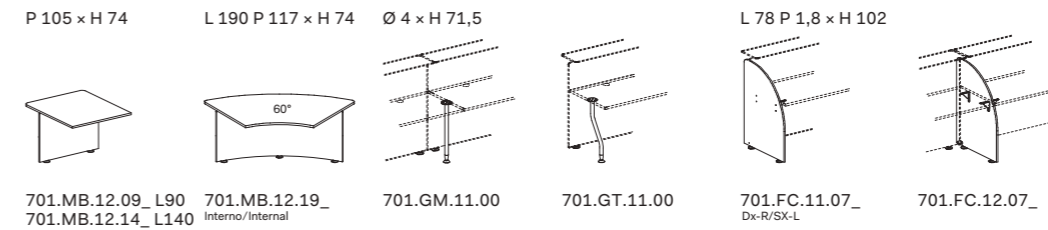

Cassettiere su ruote / Pedestals on castors

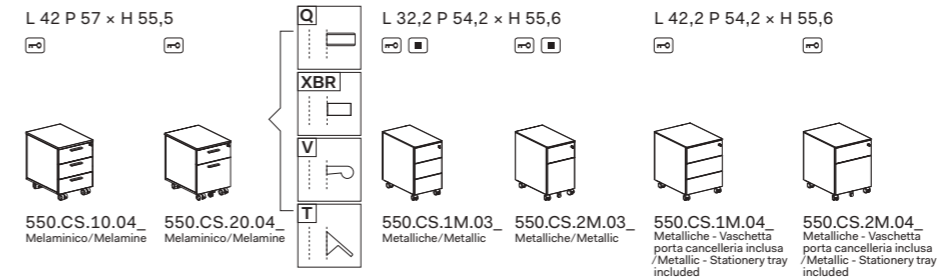

Note: Per portacancelleria cassetti, vedi capitolo DV300-Accessori / For stationary tray, see chapter DV300-Accessories.

Canalizzazione – Elettificazione / Wire-Management – Electrification

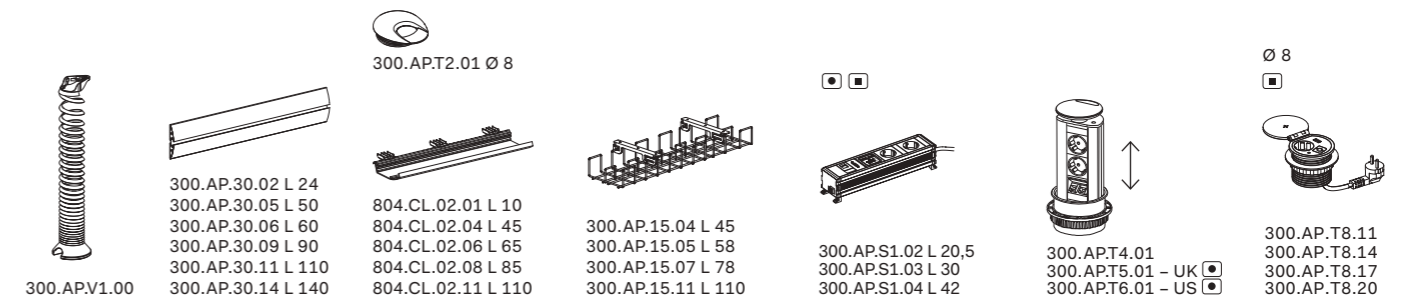

Accessori / Accessories

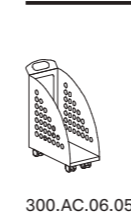

300.AC.06.05

Bracci porta video / Arms for video support

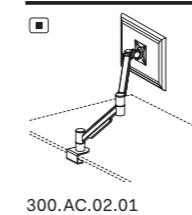

300.AC.02.01  
Braccio porta video mobile su piano / Dynamic arm for video support on deskbase

Note:

- 1 Per la scelta dei contenitori e degli accessori vari, consultare il relativo listino o catalogo / To choose storage units and accessories, please check correspondent price list or catalogue;
- 2 Le dimensioni sono espresse in cm – consultare il listino prezzi per le caratteristiche tecniche, i codici degli articoli e delle finiture / Dimensions are stated in cm – for technical characteristics, article code numbers and finishing see price list;
- 3 Progettare la composizione del bancone ed aggiungere: n°1 gamba intermedia, o fianco intermedio per ogni collegamento tra due moduli; n°1 gamba terminale Dx o Sx o fianco terminale Dx o Sx per ogni lato finale del bancone; / When designing the counter composition, add the following elements: n°1 middle leg or middle side for each connection between two counters; n°1 terminal leg (RH or LH) or terminal side (RH or LH) on each side of the counter unit;
- Prodotti non in pronta consegna. Per la disponibilità contattare l'ufficio commerciale / Items not in prompt delivery. Please contact the commercial department to check availability;
- Articoli prodotti solo su richiesta / Items produced only on demand;
- Con serratura / With lock.

# Qubo

DV703

Minimalismo e pulizia progettuale. La collezione si presenta come elemento dedicato all'accoglienza. I banconi da reception per ufficio sono caratterizzati da elementi semplici che, accostati tra di loro, definiscono lo spazio di primo contatto.

*Minimalism and clean design. The collection is presented as an element dedicated to hospitality. The reception desks for offices are characterized by simple elements which, combined with each other, define the space of first contact.*









Il piano conversazione si integra perfettamente con i diversi moduli bancone e consente di creare uno spazio di grande utilità sia per gli operatori che per il pubblico, senza compromettere l'estetica e la funzione della composizione realizzata.

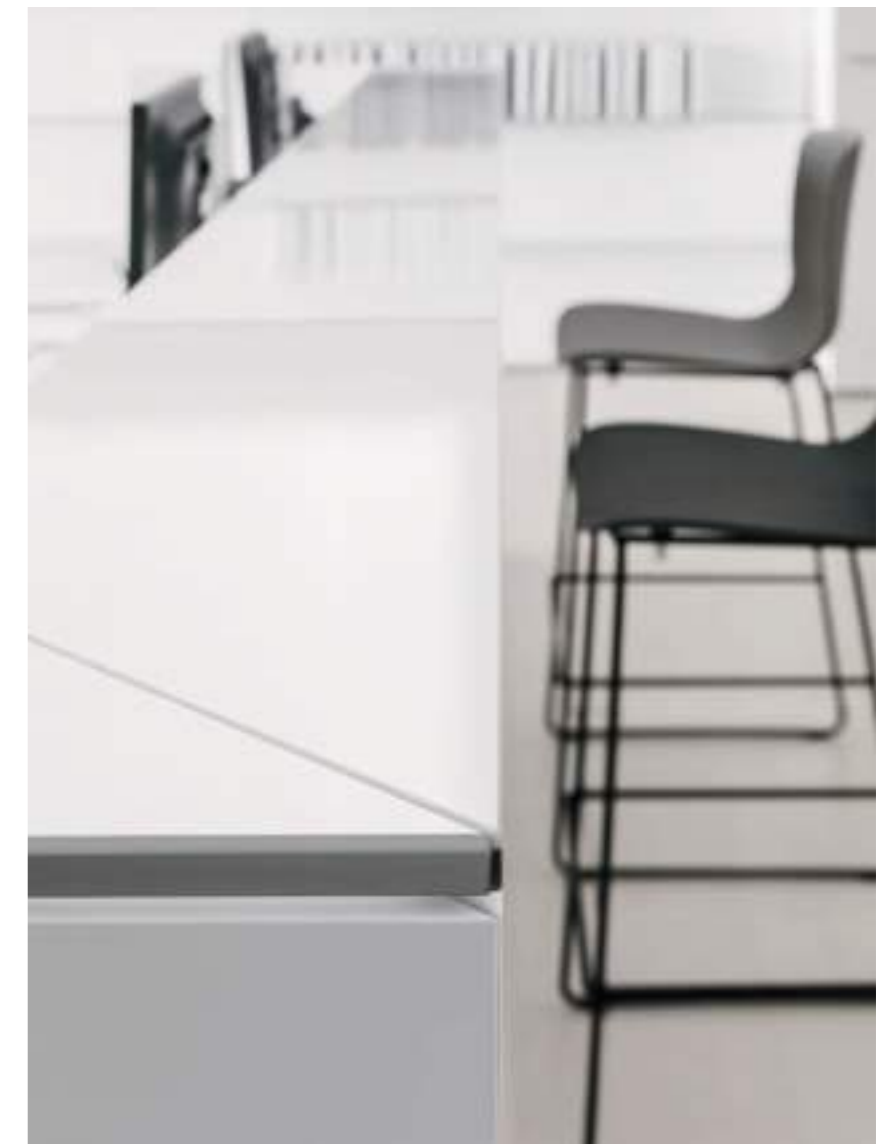

*The conversation worktop, seamlessly integrated within the different counter modules, gives a space of great use both to the operator and the public alike, without compromising the aesthetic and function of the counter-desk.*



Per arricchire la serie,  
è stato integrato un  
"top accettazione"  
che si abbina in modo  
elegante alle diverse  
finiture del bancone.

*To enrich the series, a  
"decorative top" has  
been integrated that  
elegantly combines  
with the different  
finishes of the counter.*









Il disegno ricercato e particolare dei top terminali, caratterizza e rende riconoscibile lo stile di questa reception, anche nelle composizioni più semplici e lineari.

*The particular design of the terminal tops provides the character and style of this reception desk, even in the most simple and linear compositions.*





Moduli bancone / Counter modules

Pannelli verticali sp. 2.5 cm, in melaminico con bordi in ABS sp. 0.15 cm / Vertical panels 2.5 cm thick, in melamine with ABS edge-profile 0.15 cm thick

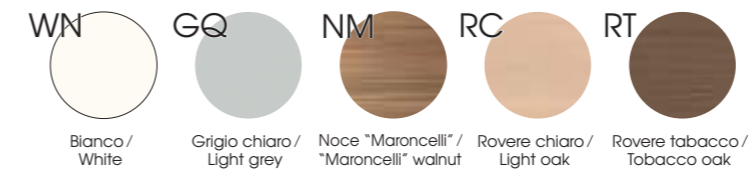

Plani di lavoro sp. 2.5 cm, in melaminico con bordi in ABS sp. 0.2 cm / Worktops 2.5 cm thick, in melamine with ABS edge-profile 0.2 cm thick

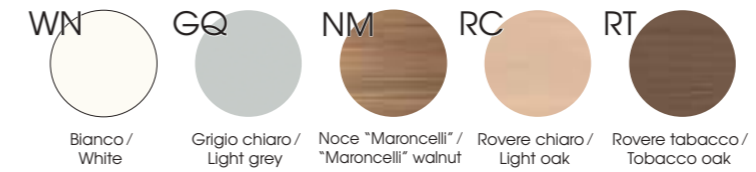

Abbinamento tops / Tops combinations

Top sp. 1.8 cm, in melaminico (\*) o laminato (\*\*\*) con bordi in PMMA bicolore sp. 0.15 cm / Top 1.8 cm thick, melamine (\*) or laminate (\*\*\*) with PMMA edges-profiles 0.15 thick

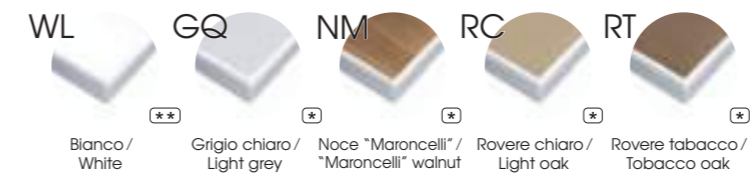

Colonna metallica / Metal column



Zoccoli in alluminio / Aluminium plinth



Supporti in zama / Supports in zamak

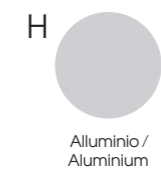

Box multiuso / Storage box

Box sp. 1 cm, in melaminico con bordi in ABS colore alluminio sp. 0.1 cm / Box 1 cm thick, in melamine with ABS edges-profiles 0.1 cm thick



Composizione in gres / Gres composition



Top accettazione / Decorative top



Note

Prodotti non in pronta consegna. Per la disponibilità contattare l'ufficio commerciale / Items not in prompt delivery. Please contact the commercial department to check availability

Moduli bancone standard/Standard counter units

<p>P 84 x H 112,5</p> <p>703.MB.01.08_ L 80 703.MB.01.14_ L 140 703.MB.01.16_ L 160 703.MB.01.20_ L 200</p> <p>Moduli dritti/Straight counter units</p>	<p>L 84 P 84 x H 112,5</p> <p>703.MB.03.08_ Raccordo 90° a 2 vie /2 ways 90° connection unit</p>	<p>L 84 P 84 x H 112,5</p> <p>703.MB.04.08_ Terminale 90° Dx-Sx /Terminal counter unit 90° R - L</p>
---	--	--

Componenti per moduli bancone/Components for counter units

<p>P 2,5 x H 110</p> <p>703.SQ.01.08_ L 80 703.SQ.01.14_ L 140 703.SQ.01.16_ L 160 703.SQ.01.20_ L 200</p> <p>Schiene per moduli dritti /Back panels for straight units</p>	<p>L 84 P 84 x H 110</p> <p>703.SQ.02.08_ Schiene per moduli 90° /Back panels for 90° units</p>	<p>P 80 x H 2,5</p> <p>703.PQ.01.08_ L 80 703.PQ.01.14_ L 140 703.PQ.01.16_ L 160 703.PQ.01.20_ L 200</p> <p>Piani scrivania per moduli dritti /Worktops for straight units</p>	<p>L 80 P 80 x H 2,5</p> <p>703.PQ.02.08_ Piani scrivania per moduli 90° /Worktops for 90° units</p>
---	---	---	--

Componenti per moduli bancone/Components for counter modules

<p>P 30 x H 1,8</p> <p>703.TQ.01.08_ L 80 703.TQ.01.14_ L 140 703.TQ.01.16_ L 160 703.TQ.01.20_ L 200</p> <p>Top per moduli dritti /Top for straight units</p>	<p>L 84 P 84 x H 1,8</p> <p>703.TQ.02.08_ Top per raccordo 90° a 2 vie /Top for 90° units</p>	<p>L 84 P 84 x H 1,8</p> <p>703.TQ.03.08_ Top per terminali 90° Dx - Sx /R - L top for 90° terminal units</p>	<p>L 84 P 2,5 x H 112,5</p> <p>703.FC.01.08_ Sx/L - Dx/R 703.FC.01.08_ Fianchi terminali Dx - Sx /R - L terminal sides</p>	<p>L 5 P 5 x H 71,5</p> <p>703.GM.01.01 Colonna intermedia /Intermediate slim column</p>	<p>P 2,5 x H 8</p> <p>703.ZB.01.08 L 80 703.ZB.01.14 L 140 703.ZB.01.16 L 160 703.ZB.01.20 L 200</p> <p>Zoccoli per moduli dritti/Metal plinth for straight units (Optional)</p>	<p>L 84 P 84 x H 8</p> <p>703.ZB.02.08 Zoccoli per moduli 90° /Metal plinth for 90° units (Optional)</p>
--	---	---	--	--	--	--

⊗ Non utilizzabile come terminale/It cannot be used as a terminal side      ⊠ Componenti non collegabili con modulo conversazione/Items that cannot be connected with the conversation counter units

Moduli bancone con piano conversazione/Counter units with conversation top

<p>L 140 P 115 x H 74</p> <p>703.MB.02.14_ Modulo conversazione /Conversation counter unit</p>	<p>L 140 P 2,5 x H 71,5</p> <p>703.SQ.03.14_ Schiena per modulo conversazione /Back panels for conversation unit</p>	<p>L 140 P 115 x H 2,5</p> <p>703.PQ.03.14_ Piano per modulo conversazione /Worktop for conversation unit</p>	<p>L 84 P 2,5 x H 74</p> <p>703.FC.03.08_ Sx/L - Dx/R 703.FC.03.08_ Fianchi terminali per modulo conversazione /Terminal sides for conversation unit</p>	<p>L 28 P 2,5 x H 39</p> <p>703.CT.A1.02_ Sx/L - Dx/R 703.CT.A1.02_ Fianchetti superiori per modulo conversazione /Small sides for conversation panels</p>
--	--	---	--	--

⊠ Gli zoccoli sono optional e non sono previsti per i fianchi terminali / The aluminium plinths are optional and are not intended for end panels

Top accettazione/Decorative top

<p>P 32,3 x H 74</p> <p>703.TA.01.14_ L 140 703.TA.01.16_ L 160</p>	<p>L 42 P 65 x H 72,2</p> <p>703.LQ.02.14_ L 140 703.LQ.02.16_ L 160</p>
---	--

Cassettiere portanti/Carrying pedestals

<p>L 42 P 65 x H 72,2</p> <p>550.CS.30.04_ Cassettiere senza top per integrazione sotto il piano di lavoro /Pedestals without top to be integrated under the worktop</p>	<p>H 1,8</p> <p>550.CS.40.04_ Zoccolo (Optional) /Base frame (Optional)</p>
--	---

Cassettiere/Pedestals

<p>L 42 P 57 x H 55,5</p> <p>550.CS.10.04_ Melaminico/Melamine 550.CS.20.04_ Melaminico/Melamine</p>	<p>L 32,2 P 54,2 x H 55,6</p> <p>550.CS.1M.03_ Metalliche/Metallic 550.CS.2M.03_ Metalliche/Metallic</p>	<p>L 42,2 P 54,2 x H 55,6</p> <p>550.CS.1M.04_ Metalliche - Vaschetta porta cancelleria inclusa /Metallic - Stationery tray included 550.CS.2M.04_ Metalliche - Vaschetta porta cancelleria inclusa /Metallic - Stationery tray included</p>
--	--	--

[Note:] Per portacancelleria cassetti, vedi capitolo DV300-Accessori / For stationary tray, see chapter DV300-Accessories.

Composizione in gres/Gres composition

L 247 P 84 x H 112,5

703.CM.P1

Bracci porta video/Arms for video support

300.AC.02.01

Braccio porta video mobile su piano /Dynamic arm for video support on deskbase

Accessori/Accessories

L 35 P 24 x H 35

300.AC.14.03

Canalizzazione - Elettrificazione/Wire-Management - Electrification

<p>300.AP.V1.00</p>	<p>300.AP.15.05 L 58 For 703.MB.01.08_/703.MB.04.08_ 300.AP.15.08 L 88 For 703.MB.01.20_ 300.AP.15.11 L 110 For 703.MB.01.14_/703.MB.02.14_ 300.AP.15.14 L 140 For 703.MB.01.16_</p>	<p>703.AP.01.04 L 45 For 703.MB.03.08_</p>	<p>300.AP.S1.02 L 20,5 300.AP.S1.03 L 30 300.AP.S1.04 L 42</p>	<p>300.APT4.01 300.APT5.01 - UK 300.APT6.01 - US</p>	<p>300.AP.T8.11 300.AP.T8.14 300.AP.T8.17 300.AP.T8.20</p>
---------------------	--	--	--	--	--

<p>300.AP.T2.01 Ø 8</p>	<p>300.AP.T7.01 Ø 6 300.AP.T8.01 Ø 8</p>	<p>703.LQ.03.00 L 55</p>	<p>703.KQ.03.00 15W/100 - 240V ± 12V</p>
-------------------------	--	--------------------------	--

300.AC.06.05\_

Note:

- Progettare la composizione del bancone ed aggiungere: n°1 gamba intermedia per ogni collegamento tra due moduli; n° 1 fianco terminale dx o sx, o fianco terminale conversazione per ogni lato finale del bancone; copertura superiore per ogni collegamento tra modulo conversazione e modulo bancone / When designing the counter composition, add the following elements: n°1 middle leg for each connection between two counters; n°1 terminal side (RH or LH), or terminal side for conversation counter unit on each side of the counter unit; upper cover element for the connection between the conversation counter unit and the standard counter unit;
- Per la scelta dei contenitori e degli accessori vari, consultare il relativo listino o catalogo/To choose storage units and accessories, please check correspondent price list or catalogue;
- Le dimensioni sono espresse in cm - consultare il listino prezzi per le caratteristiche tecniche, i codici degli articoli e delle finiture/Dimensions are stated in cm - for technical characteristics, article code numbers and finishing see price list;
- Le schiene L=200 cm non sono disponibili noce "Maroncelli"/The back panels W=200 cm are not available in "Maroncelli" walnut.
- Prodotti non in pronta consegna. Per la disponibilità contattare l'ufficio commerciale/Items not in prompt delivery. Please contact the commercial department to check availability;
- Articoli prodotti solo su richiesta/Items produced only on demand;
- Con serratura/With lock.
- Fino ad esaurimento/Until exhaustion;